

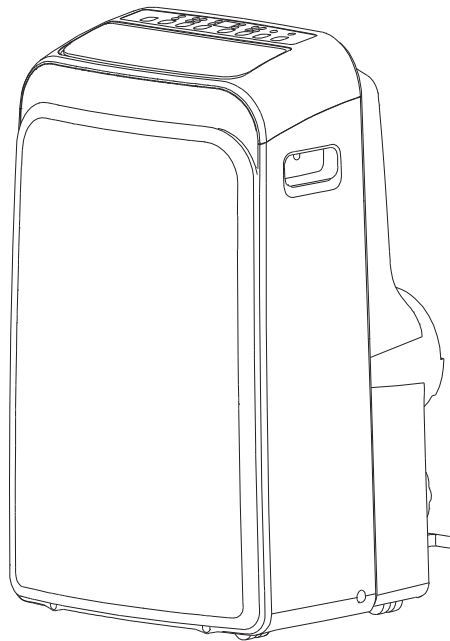

**Applicable to**  
SENP/14Z

**PORTABLE AIR CONDITIONER**

# **USER'S MANUAL**



**Thank you for purchasing of SENVILLE air conditioner.  
To guarantee safety and best efficiency, please read this manual carefully and keep a suitable storage for reference.**

# |Contents

Safety Precautions -----	2
Cautions -----	3
Preparations -----	4
Installation -----	5
Operation -----	8
Maintenance -----	11
Faults Diagnosis -----	12
Design and Compliance Notes -----	13
Sociable Remark -----	14

## Safety Precautions



This symbol indicates that ignoring instructions may cause death or serious injury.



**WARNING:** To prevent death or injury to the user or other people and property damage, the following instructions must be followed. Incorrect operation due to ignoring of instructions may cause death, harm or damage.

- Installation must be performed according to the installation instructions. Improper installation can cause water leakage, electrical shock, or fire.
- Use only the included accessories and parts, and specified tools for the installation. Using non-standard parts can cause water leakage, electrical shock, fire, and injury or property damage.
- Make sure that the outlet you are using is grounded and has the appropriate voltage. The power cord is equipped with a three-prong grounding plug to protect against shock. Voltage information can be found on the nameplate of the unit.
- Your unit must be used in a properly grounded wall receptacle. If the wall receptacle you intend to use is not adequately grounded or protected by a time delay fuse or circuit breaker (the fuse or circuit breaker needed is determined by the maximum current of the unit. The maximum current is indicated on the nameplate located on unit), have a qualified electrician install the proper receptacle.
- Install the unit on a flat, sturdy surface. Failure to do so could result in damage or excessive noise and vibration.
- The unit must be kept free from obstruction to ensure proper function and to mitigate safety hazards.
- DO NOT modify the length of the power cord or use an extension cord to power the unit.
- DO NOT share a single outlet with other electrical appliances. Improper power supply can cause fire or electrical shock.
- DO NOT install your air conditioner in a wet room such as a bathroom or laundry room. Too much exposure to water can cause electrical components to short circuit.
- DO NOT install the unit in a location that may be exposed to combustible gas, as this could cause fire.
- The unit has wheels to facilitate moving. Make sure not to use the wheels on thick carpet or to roll over objects, as these could cause tipping.
- DO NOT operate a unit that it has been dropped or damaged.
- The appliance with electric heater shall have at least 1 meter space to the combustible materials.
- Do not touch the unit with wet or damp hands or when barefoot.
- If the air conditioner is knocked over during use, turn off the unit and unplug it from the main power supply immediately. Visually inspect the unit to ensure there is no damage. If you suspect the unit has been damaged, contact a technician or customer service for assistance.
- In a thunderstorm, the power must be cut off to avoid damage to the machine due to lightning.
- Your air conditioner should be used in such a way that it is protected from moisture. e.g. condensation, splashed water, etc. Do not place or store your air conditioner where it can fall or be pulled into water or any other liquid. Unplug immediately if it occurs.
- All wiring must be performed strictly in accordance with the wiring diagram located inside of the unit.
- The unit's circuit board(PCB) is designed with a fuse to provide overcurrent protection. The specifications of the fuse are printed on the circuit board, such as: T 3.15A/250V, etc.

## Cautions



### Cautions

- This appliance can be used by children aged from 8 years and above and person with reduced physical, sensory or mental capabilities or lack of experience and knowledge if they have been given supervision or instruction concerning use of the appliance in a safe way and understand the hazards involved. Children shall not play with the appliance. Cleaning and user maintenance shall not be made by children without supervision. (be applicable for the European Countries)
- This appliance is not intended for use by persons (including children) with reduced physical, sensory or mental capabilities or lack of experience and knowledge, unless they have been given supervision or instruction concerning use of the appliance by a person responsible for their safety. (be applicable for other countries except the European Countries )
- Children should be supervised to ensure that they do not play with the appliance. Children must be supervised around the unit at all times.
- If the supply cord is damaged, it must be replaced by the manufacturer, its service agent or similarly qualified persons in order to avoid a hazard.
- Prior to cleaning or other maintenance, the appliance must be disconnected from the supply mains.
- Do not remove any fixed covers. Never use this appliance if it is not working properly, or if it has been dropped or damaged.
- Do not run cord under carpeting. Do not cover cord with throw rugs, runners, or similar coverings. Do not route cord under furniture or appliances. Arrange cord away from traffic area and where it will not be tripped over.
- Do not operate unit with a damaged cord, plug, power fuse or circuit breaker. Discard unit or return to an authorized service facility for examination and/or repair.
- To reduce the risk of fire or electric shock, do not use this fan with any solid-state speed control device.
- The appliance shall be installed in accordance with national wiring regulations.
- Contact the authorised service technician for repair or maintenance of this unit.
- Contact the authorised installer for installation of this unit.
- Do not cover or obstruct the inlet or outlet grilles.
- Do not use this product for functions other than those described in this instruction manual.
- Before cleaning, turn off the power and unplug the unit.
- Disconnect the power if strange sounds, smell, or smoke comes from it.
- Do not press the buttons on the control panel with anything other than your fingers.
- Do not remove any fixed covers. Never use this appliance if it is not working properly, or if it has been dropped or damaged.
- Do not operate or stop the unit by inserting or pulling out the power cord plug.
- Do not use hazardous chemicals to clean or come into contact with the unit. Do not use the unit in the presence of inflammable substances or vapour such as alcohol, insecticides, petrol, etc.
- Always transport your air conditioner in a vertical position and stand on a stable, level surface during use.
- Always contact a qualified person to carry out repairs. If the damaged power supply cord must be replaced with a new power supply cord obtained from the product manufacturer and not repaired.
- Hold the plug by the head of the power plug when taking it out.
- Turn off the product when not in use.

# Preparation

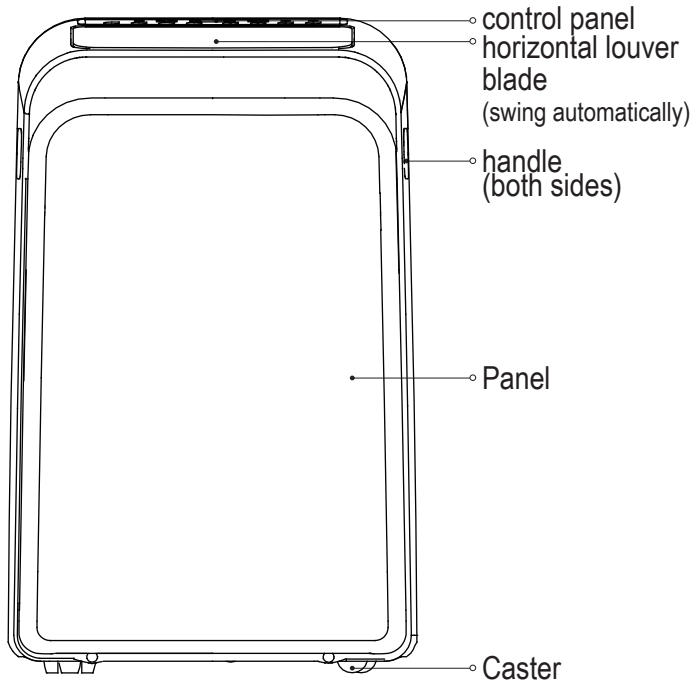

front

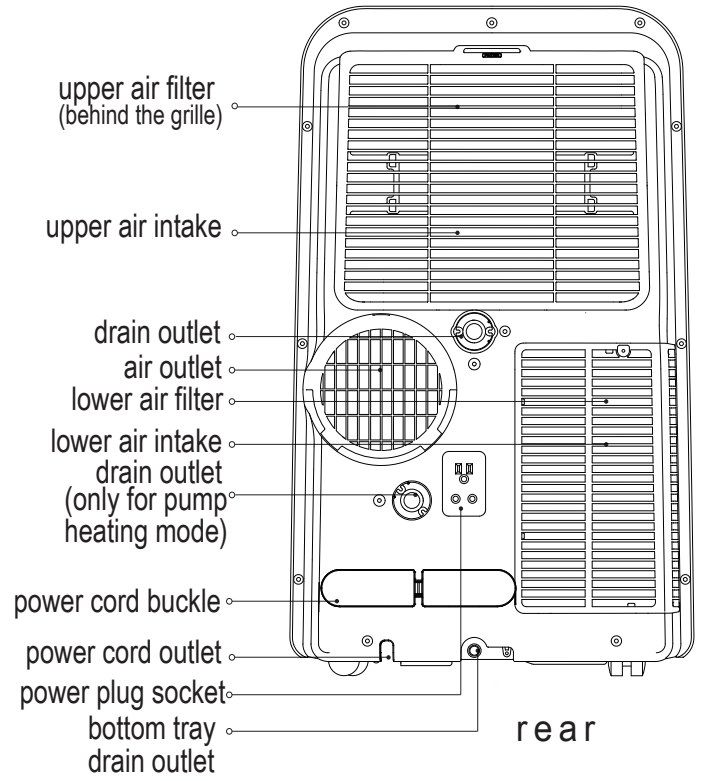

rear

MODEAL A

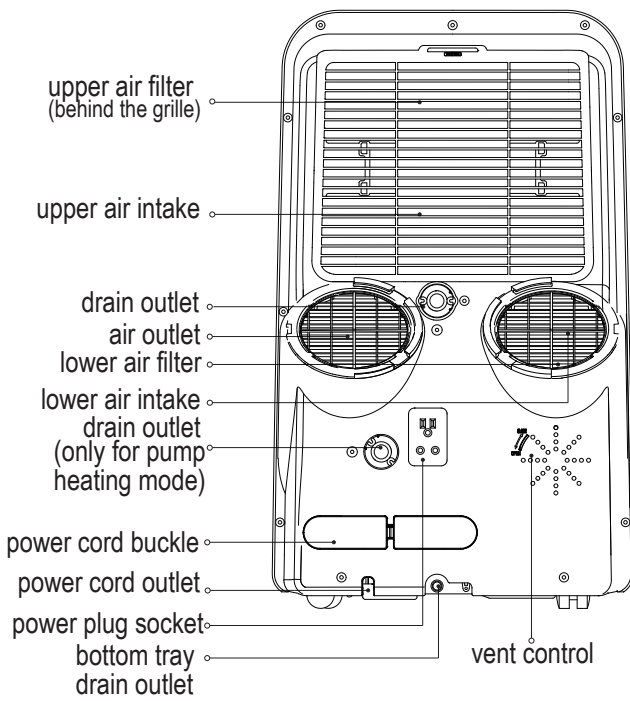

rear

MODEAL B

# Installation

## Choosing The Right Location

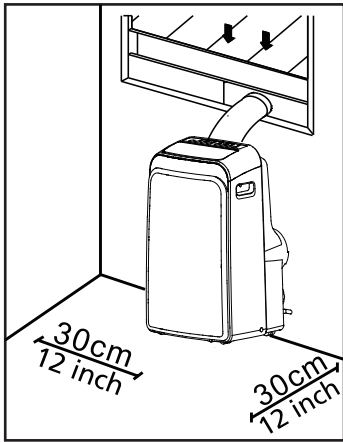

Your installation location should meet the following requirements:

- Make sure that you install your unit on an even surface to minimize noise and vibration.
- The unit must be installed near a grounded plug, and the Collection Tray Drain (found on the back of the unit) must be accessible.
- The unit should be located at least 30cm (12”) from the nearest wall to ensure proper air conditioning.
- DO NOT cover the Intakes, Outlets or Remote Signal Receptor of the unit, as this could cause damage to the unit.

## Recommend Installation

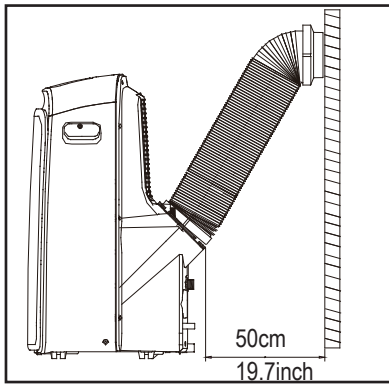

### NOTE:

All the illustrations in the manual are for explanation purpose only. Your machine may be slightly different. The actual shape shall prevail.

The unit can be controlled by the unit control panel alone or with the remote controller. This manual does not include Remote Controller Operations, see the <<Remote Control Illustration>> packed with the unit for details.

When there are wide differences between “INSTRUCTION MANUAL” and “Remote control Illustration” on function description, the description on “INSTRUCTION MANUAL ” shall prevail.

## Tools Needed

-Medium Philips screwdriver; -Tape measure or ruler; -Knife or scissors; -Saw (optional, to shorten window adaptor for narrow windows)

## Accessories

Check your window size and choose the fit window slider.













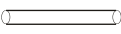

North America

Part	Description	Quantity		Part	Description	Quantity
		single-exhaust unit(MODEL A)	double-exhaust unit(MODEL B)			
	Unit Adaptor	1 pc	2 pc		Bolt	1 pc
	Exhaust Hose	1 pc	2 pc		Security Bracket and Screw	1 set
	Window Slider Adaptor	1 pc	2 pc		Drain Hose	1 pc
	Window Slider A	1 pc	—		Drain Hose Adaptor(only for heat pump mode)	1 pc
	Window Slider A	—	1 pc		Power Cord Buckle	1 pc
	Window Slider B	1 pc			Window Slider C(optional)	1 pc
	Foam Seal A (Adhesive)	2 pc			Bolt(optional)	1 pc
	Foam Seal B (Adhesive)	2 pc			Foam Seal A (Adhesive)(optional)	2 pc
	Foam Seal C (Non-adhesive)	1 pc			Foam Seal B (Adhesive)(optional)	2 pc
	Remote Controller and Battery	1 set			Foam Seal C (Non-adhesive)(optional)	1 pc

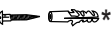
NOTE: Items with \* are optional. Slight variations in design may occur.

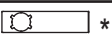
# Installation

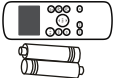
## Other Regions

Part	Description	Quantity	Part	Description	Quantity
	Unit Adaptor	1 pc	 *	Bolt	1 pc
	Exhaust Hose	1 pc	 *	Security Bracket and Screw	1 set
 *	Window Slider Adaptor	1 pc		Drain Hose	1 pc
 *	Wall Exhaust Adaptor A (only for wall installation)	1 pc		Drain Hose Adaptor(only for heat pump mode)	1 pc
 *	Wall Exhaust Adaptor B(with cap) (only for wall installation)	1 pc	 *	Foam Seal A (Adhesive)	2 pc
 *	Screw and anchor (only for wall installation)	4 set	 *	Foam Seal B (Adhesive)	2 pc
 *	Window Slider A	1 pc	 *	Foam Seal C (Non-adhesive)	1 pc
 *	Window Slider B	1 pc		Remote Controller and Battery	1 set
	Power Cord Buckle	1 pc			

NOTE: Items with \* are optional. Slight variations in design may occur.

### Window Installation Kit

**Step One: Preparing the Exhaust Hose assembly**  
Press the exhaust hose into the window slider adaptor and unit adaptor, clamp automatically by elastic buckles of the adaptors.

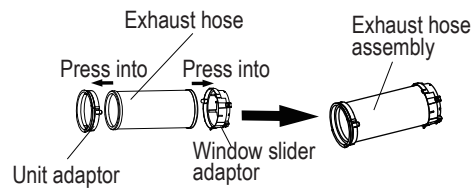

**Step Two: Install the Exhaust hose assembly to the unit**  
Type round:

Insert unit adaptor of the Exhaust hose assembly into the lower groove of the air outlet of the unit while the hook of the adaptor is aligned with the hole seat of the air outlet and slide down the Exhaust hose assembly along the arrow direction for installation.

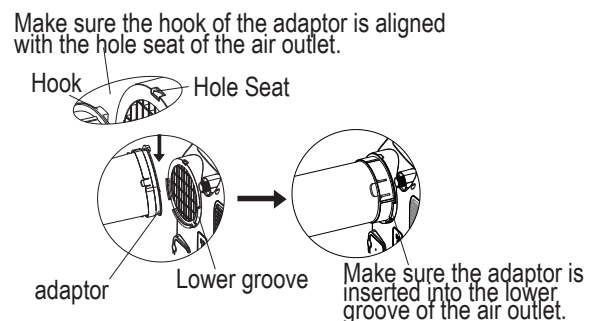

### Step Three: Preparing the Adjustable Window Slider

- Depending on the size of your window, adjust the size of the window slider.
- If the length of the window requires two window sliders, use the bolt to fasten the window sliders once they are adjusted to the proper length.
- For some models, if the length of the window requires three window sliders(optional), use two bolts to fasten the window sliders once they are adjusted to proper length.

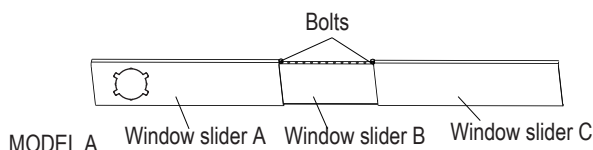
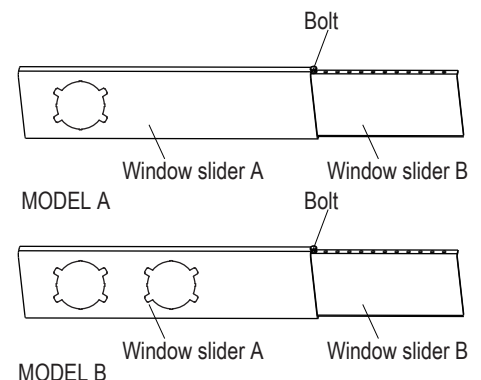

or

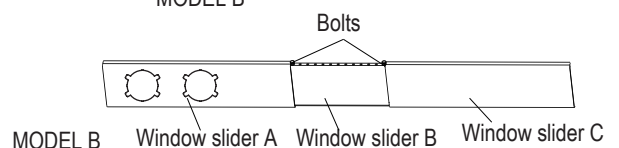

# Installation

Note: Once the Exhaust Hose assembly and Adjustable Window Slider are prepared, choose from one of the following installation methods.

## Type 1: Hung Window or Sliding Window Installation(optional)

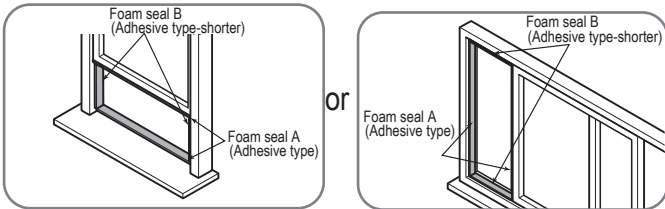

1. Cut the adhesive foam seal A and B strips to the proper lengths, and attach them to the window sash and frame as shown.

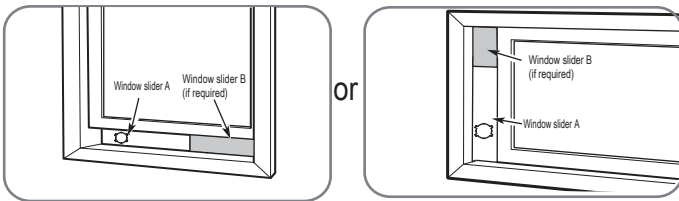

2. Insert the window slider assembly into the window opening.

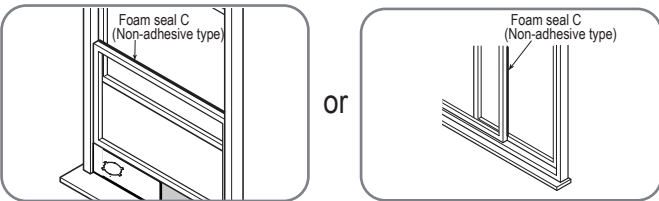

3. Cut the non-adhesive foam seal C strip to match the width of the window. Insert the seal between the glass and the window frame to prevent air and insects from getting into the room.

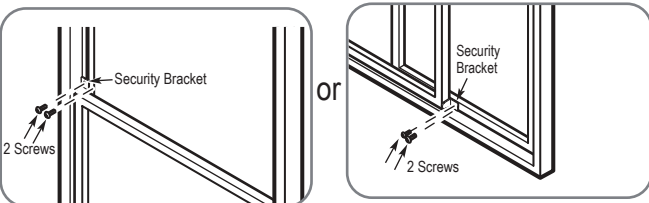

4. If desired, install the security bracket with 2 screws as shown.

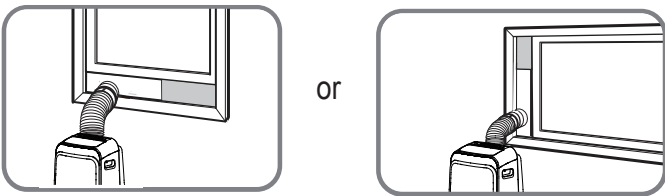

MODEL A

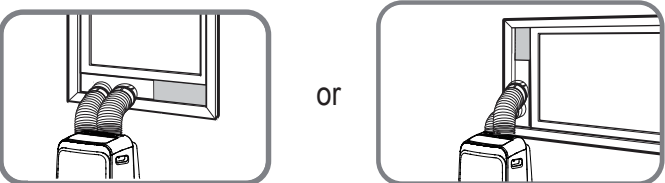

MODEL B

5. Insert the window slider adaptor into the hole of the window slider.

## Type 2: Wall Installation(optional)

1. Cut a 125mm (4.9inch) hole into the wall for the Wall Exhaust Adaptor B. 2. Secure the Wall Exhaust Adaptor B to the wall using the four Anchors and Screws provided in the kit. 3. Connect the Exhaust Hose Assembly(with Wall Exhaust Adaptor A) to the Wall Exhaust Adaptor B.

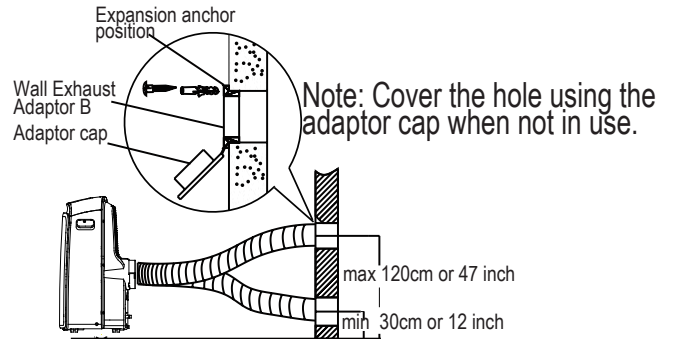

Note: To ensure proper function, DO NOT overextend or bend the hose. Make sure that there is no obstacle around the air outlet of the exhaust hose (in the range of 500mm) in order to the exhaust system works properly. All the illustrations in this manual are for explanation purpose only. Your air conditioner may be slightly different. The actual shape shall prevail.

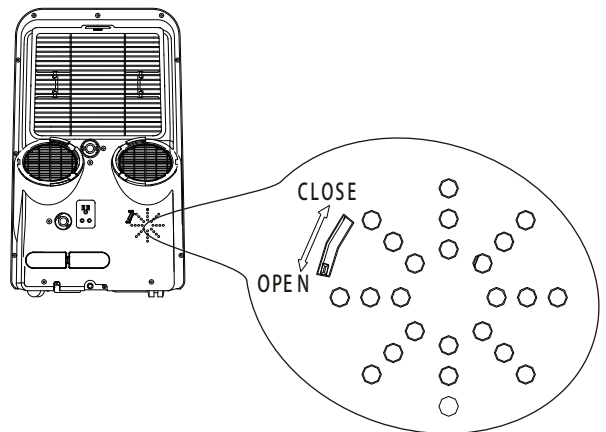

The Vent Control is located at the back of the air conditioner. The OPEN position removes stale air from the room and exhausts it to the outside. Fresh air is drawn in through normal passages in the home. When not need to circulate the room air, set Vent Control to CLOSE position. This function is only applicable for MODEL B.



## | Design and Compliance Notes

### Design Notice

The design and specifications are subject to change without prior notice for product improvement. Consult with the sales agency or manufacturer for details. Any updates to the manual will be uploaded to the service website, please check for the latest version.

### Energy Rating Information

The Energy Rating for this unit is based on an installation using an un-extended exhaust duct without window slider adaptor or wall exhaust adaptor A (as shown in the Installation section of this manual).

### Unit Temperature Range

Mode	Temperature Range
Cool	17-35°C (62-95°F)
Dry	13-35°C (55-95°F)
Heat(pump heat mode)	5-30°C (41-86°F)
Heat(electrical heat mode)	≤ 30°C (86°F)

### Note About Fluorinated Gasses

- Fluorinated greenhouse gases are contained in hermetically sealed equipment. For specific information on the type, the amount and the CO<sub>2</sub> equivalent in tonnes of the fluorinated greenhouse gas(on some models), please refer to the relevant label on the unit itself.
- Installation, service, maintenance and repair of this unit must be performed by a certified technician.
- Product uninstallation and recycling must be performed by a certified technician.

## | Sociable Remark

When using this unit in the European countries, the following information must be followed:

**DISPOSAL:** Do not dispose this product as unsorted municipal waste. Collection of such waste separately for special treatment is necessary.

It is prohibited to dispose of this appliance in domestic household waste.

For disposal, there are several possibilities:

- A) The municipality has established collection systems, where electronic waste can be disposed of at least free of charge to the user.
- B) When buying a new product, the retailer will take back the old product at least free of charge.
- C) The manufacture will take back the old appliance for disposal at least free of charge to the user.
- D) As old products contain valuable resources, they can be sold to scrap metal dealers.

Wild disposal of waste in forests and landscapes endangers your health when hazardous substances leak into the ground-water and find their way into the food chain.

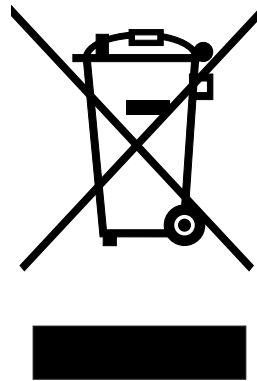



# **AIR CONDITIONER**

## **REMOTE CONTROL ILLUSTRATION**

Thank you very much for purchasing our air conditioner. Please read this owner's manual carefully before using your air conditioner. Keep it for future reference.

---

# CONTENTS

Remote control Specifications.....	2
Function buttons .....	3
Handling the remote control....	4
Remote LED screen indicators .....	5
How to use the basic functions.....	6
How to use the advanced functions .....	13

## Remote Control Specifications

Model	RG57H(B)/BG(C)E; RG57H1(B)/BG(C)E; RG57H2(B)/BG(C)EF;RG57H3(B)/BG(C)EFU1; RG57H3(B)/BG(C)EF;RG57H1(B)/BG(C)E-M;RG57H(B)/BG(C)EU1;RG57H4(B)/BG(C)EFU1; RG57H(B)/BG(C)E-M;RG57H(B)/BG(C)EU1-M;RG57H3(B)/BG(C)EFU1-M; RG57H1(B)/BG(C)EU1-M;RG57H5(B)/BG(C)EU1;RG57H5(B)/BG(C)CE;RG57H1(B)/BG(C)EU1; RG57H2(B)/BG(C)EFU1;RG57H3(B)/BG(C)EF;RG57H4(B)/BG(C)EF;RG57H2(B)/BG(C)EF-M; RG57H2(B)/BG(C)EFU1-M
Rated Voltage	3.0V(Dry batteries R03/LR03×2)
Signal Receiving Range	8m
Environment	-5°C~60°C(23°F~140°F)

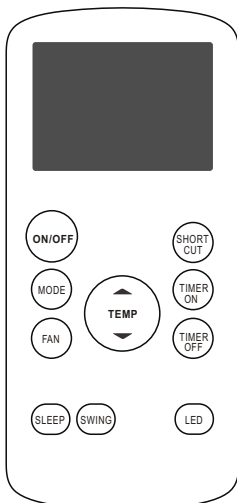

RG57H(B)/BG(C)E  
RG57H(B)/BG(C)EU1  
RG57H(B)/BG(C)EU1-M  
RG57H(B)/BG(C)E-M

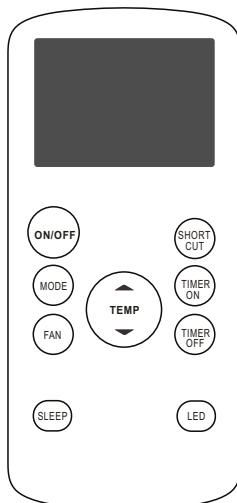

RG57H1(B)/BG(C)E;  
RG57H1(B)/BG(C)E-M  
RG57H1(B)/BG(C)EU1-M  
RG57H1(B)/BG(C)EU1

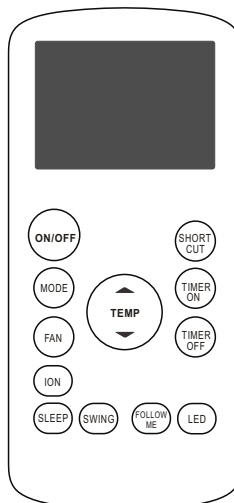

RG57H2(B)/BG(C)EF  
RG57H2(B)/BG(C)EF-M  
RG57H2(B)/BG(C)EFU1  
RG57H2(B)/BG(C)EFU1-M

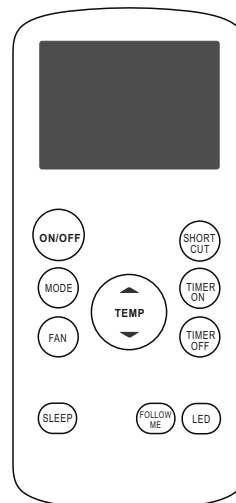

RG57H3(B)/BG(C)EF  
RG57H3(B)/BG(C)EFU1  
RG57H3(B)/BG(C)EFU1-M  
RG57H3(B)/BG(C)EF-M

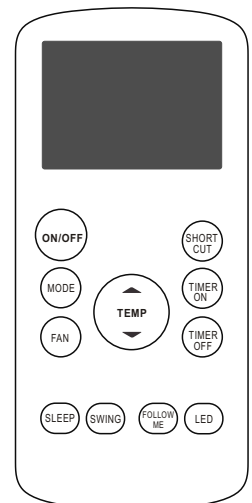

RG57H4(B)/BG(C)EFU1  
RG57H4(B)/BG(C)EF

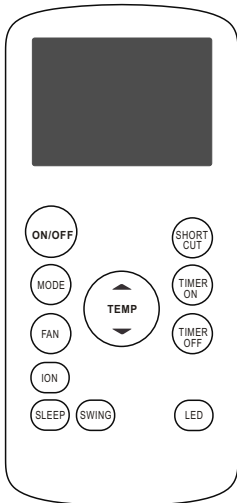

RG57H5(B)/BG(C)E  
RG57H5(B)/BG(C)EU1

## Function Buttons

Before you begin using your new air conditioner, make sure to familiarize yourself with its remote control. The following is a brief introduction to the remote control itself. For instructions on how to operate your air conditioner, refer to the **How to Use Basic Functions** section of this manual.

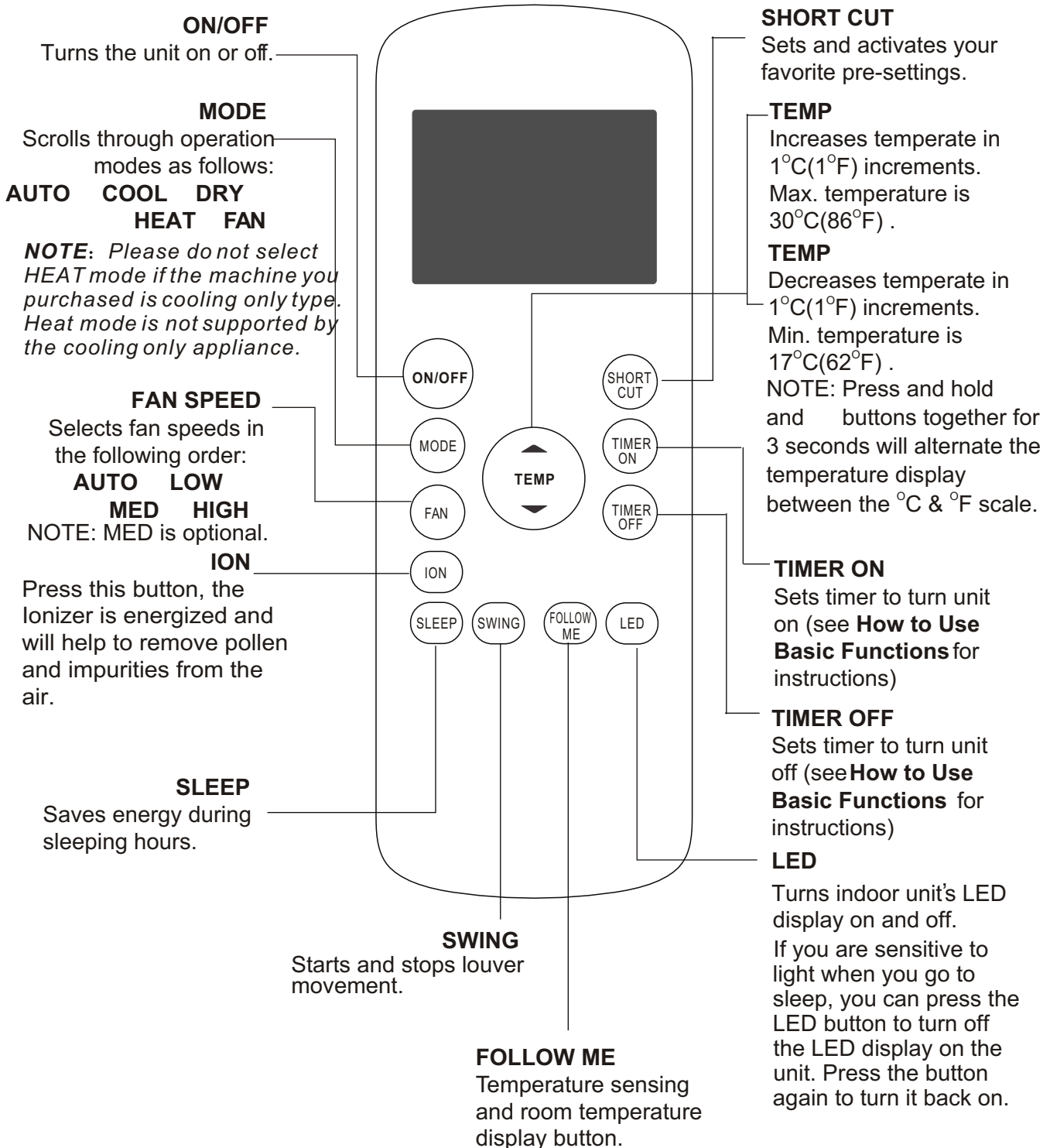

NOTE:  
Swing, Ion, Follow me and Med fan speed features are optional.

## Handling The Remote Control

### NOT SURE WHAT A FUNCTION DOES?

Refer to the How to Use Basic Functions and **How to Use Advanced Functions** sections of this manual for a detailed description of how to use your air conditioner.

### SPECIAL NOTE

- Button designs on your unit may differ slightly from the example shown.
- If the unit does not have a particular function, pressing that function's button on the remote control will have no effect.
- When there are wide differences between "Remote control Illustration" and "USER'S MANUAL" on function description, the description of "USER'S MANUAL" shall prevail.

## Inserting and Replacing Batteries

Your air conditioning unit comes with two AAA batteries. Put the batteries in the remote control before use.

1. Slide the back cover from the remote Control downward, exposing the battery compartment.
2. Insert the batteries, paying attention to match up the (+) and (-) ends of the batteries with the symbols inside the battery compartment.
3. Slide the battery cover back into place.

## ! BATTERY NOTES

For optimum product performance:

- Do not mix old and new batteries, or batteries of different types.
- Do not leave batteries in the remote control if you don't plan on using the device for more than 2 months.



## BATTERY DISPOSAL

Do not dispose of batteries as unsorted municipal waste. Refer to local laws for proper disposal of batteries.

## TIPS FOR USING REMOTE CONTROL

- The remote control must be used within 8 meters of the unit.
- The unit will beep when remote signal is received.
- Curtains, other materials and direct sunlight can interfere with the infrared signal receiver.
- Remove batteries if the remote will not be used more than 2 months.

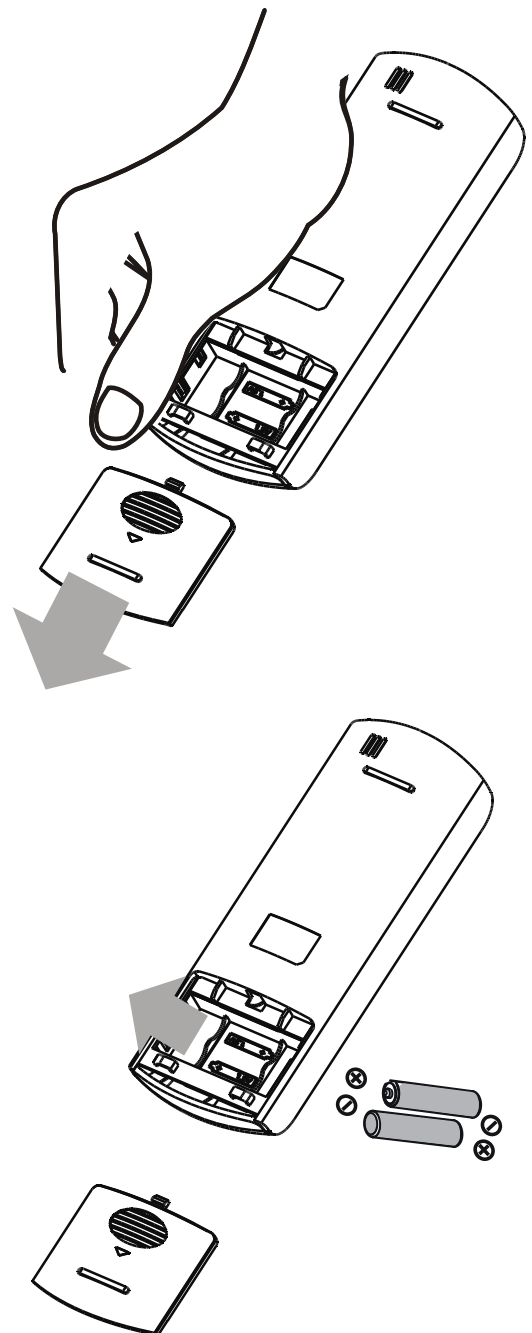



## Remote LED Screen Indicators

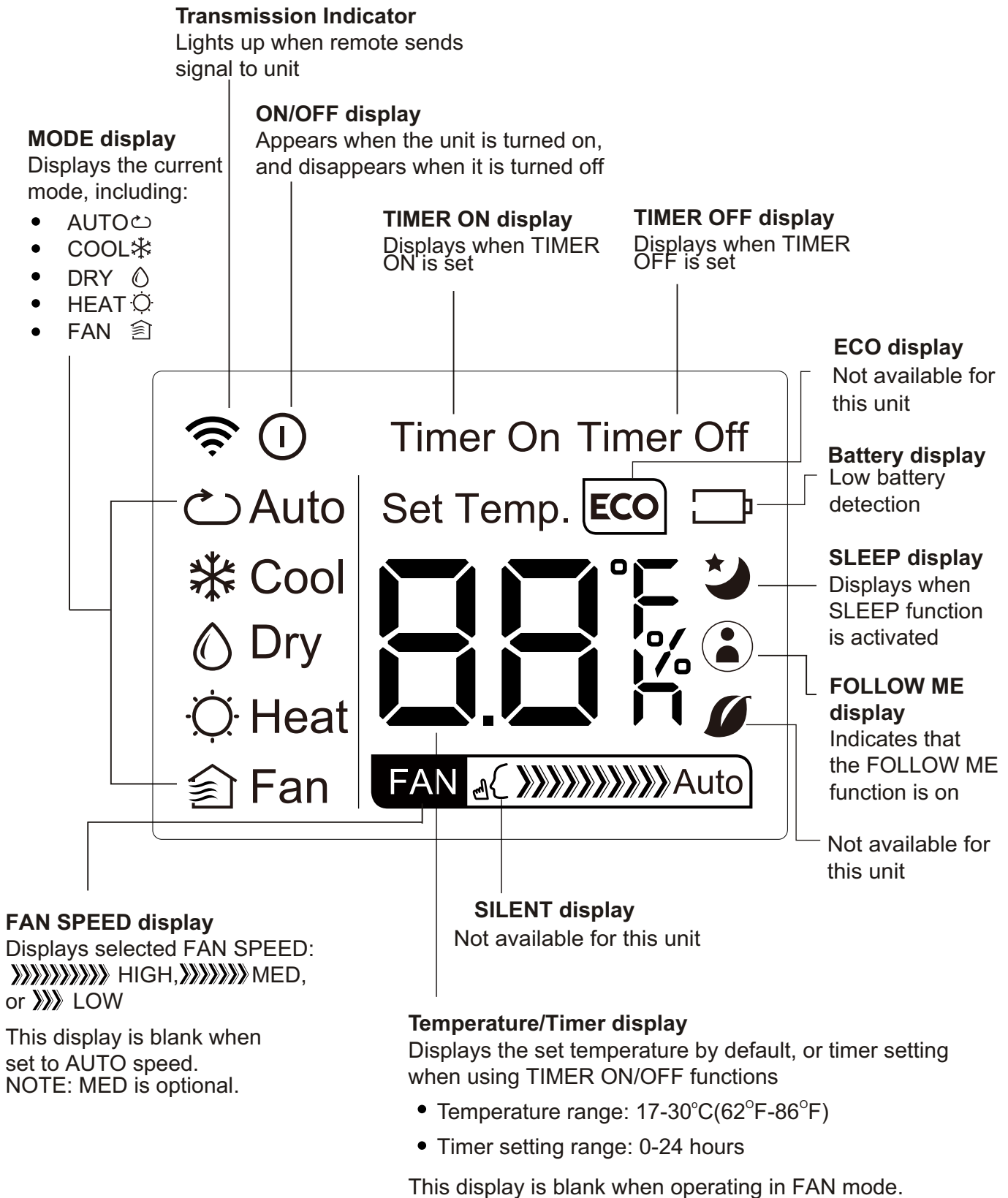

## How To Use The Basic Functions

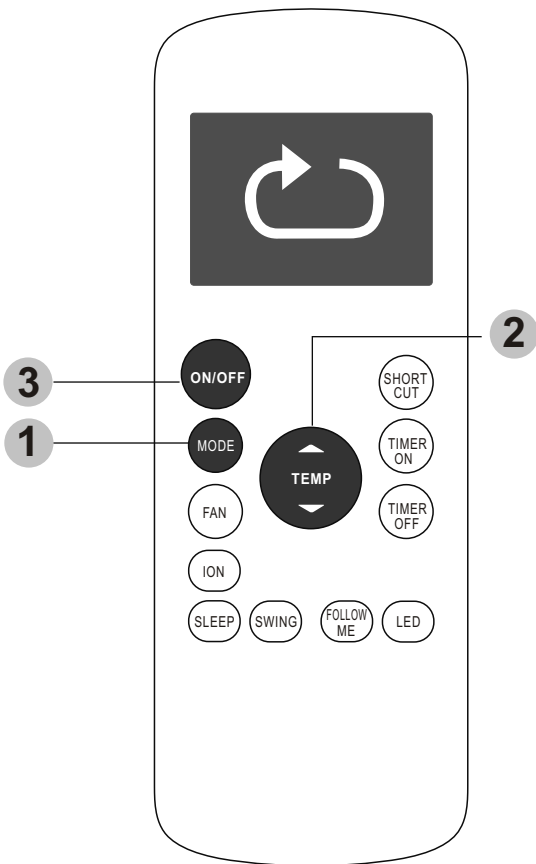

### SETTING TEMPERATURE

The operating temperature range for units is 17-30°C(62°F-86°F). You can increase or decrease the set temperature in 1°C(1°F) increments.

### AUTO operation

In **AUTO** mode, the unit will automatically select the COOL, FAN, HEAT or DRY mode based on the set temperature.

1. Press the **MODE** button to select Auto mode.
2. Set your desired temperature using the **Temp ▲** or **Temp ▼** button.
3. Press the **ON/OFF** button to start the unit.

**NOTE: FAN SPEED** can't be set in Auto mode.

### COOL operation

1. Press the **MODE** button to select **COOL** mode.
2. Set your desired temperature using the **Temp ▲** or **Temp ▼** button.
3. Press the **FAN** button to select the fan speed: AUTO, LOW, MED, or HIGH.
4. Press the **ON/OFF** button to start the unit.

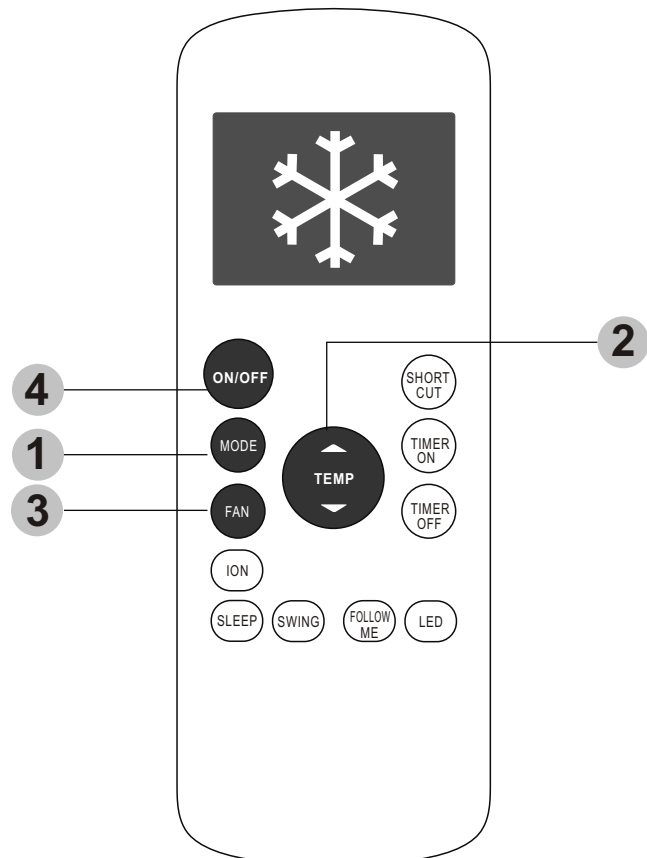

## How To Use The Basic Functions

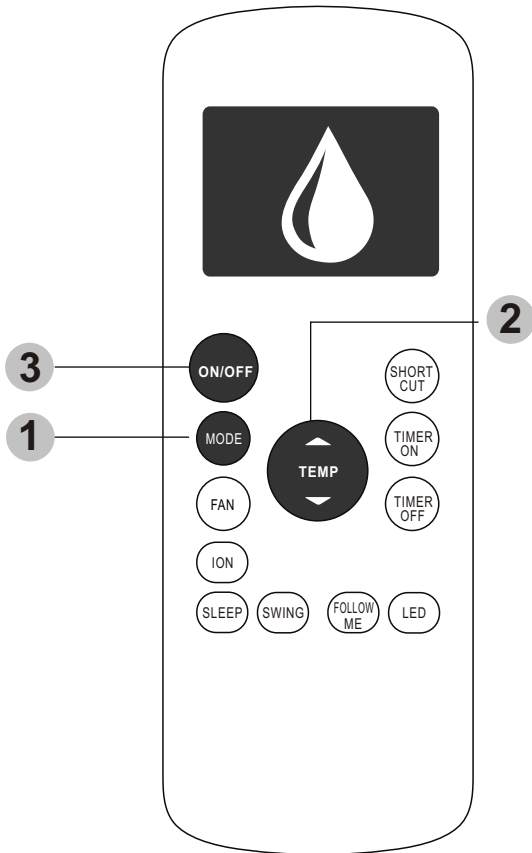

### DRY operation(dehumidifying)

1. Press the **MODE** button to select **DRY** mode.
2. Set your desired temperature using the **Temp**▲ or **Temp**▼ button.
3. Press the **ON/OFF** button to start the unit.

**NOTE:** **FAN SPEED** can't be changed in DRY mode.

### FAN operation

1. Press the **MODE** button to select FAN mode.
2. Press **FAN** button to select the fan speed: AUTO, LOW, MED or HIGH.
3. Press the **ON/OFF** button to start the unit.

**NOTE:** You can't set temperature in FAN mode. As a result, your remote control's LCD screen will not display temperature.

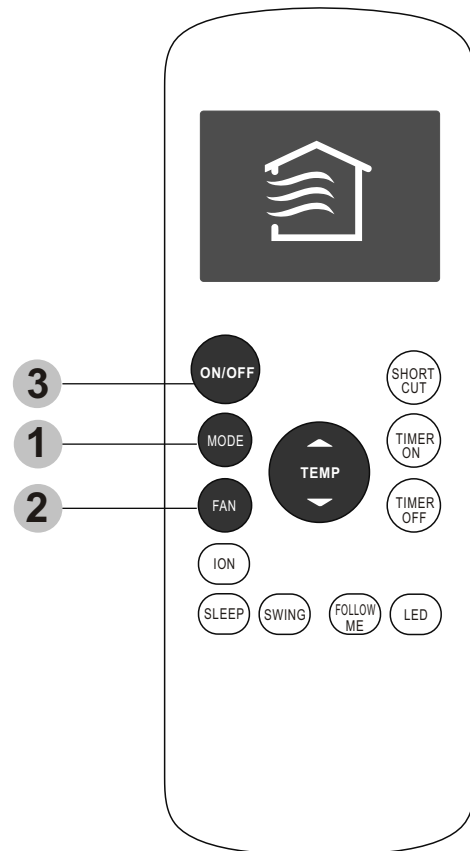

---

## How To Use The Basic Functions

### HEAT operation

1. Press the **MODE** button to select **HEAT** mode.
2. Set your desired temperature using the **Temp ▲** or **Temp ▼** button.
3. Press the **FAN** button to select the fan speed: AUTO, LOW, MED, or HIGH.
4. Press the **ON/OFF** button to start the unit.

**NOTE:** As outdoor temperature drops, the performance of your unit's HEAT function may be affected. In such instances, we recommend using this air conditioner in conjunction with other heating appliance.

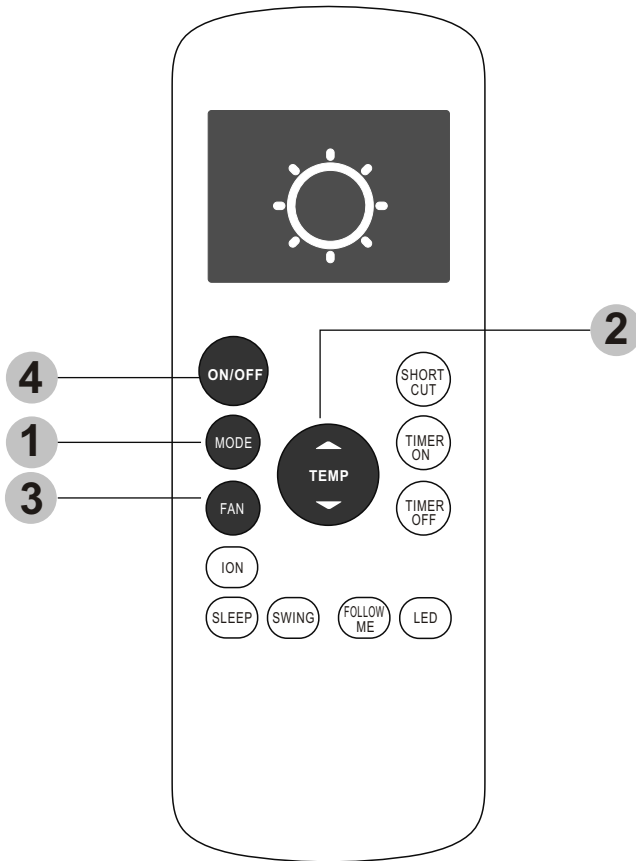

## Setting the TIMER function

Your air conditioning unit has two timer-related functions:

**TIMER ON-** sets the amount of timer after which the unit will automatically turn on.

**TIMER OFF-** sets the amount of time after which the unit will automatically turn off.

### TIMER ON function

The **TIMER ON** function allows you to set a period of time after which the unit will automatically turn on, such as when you come home from work.

1. Press the **TIMER ON** button. By default, the last time period that you set and an "h" (indicating hours) will appear on the display.  
**Note:** This number indicates the amount of time after the current time that you want the unit to turn on. For example, if you set **TIMER ON** for 2 hours, " 2.0h " will appear on the screen, and the unit will turn on after 2 hours.
2. Press the **TIMER ON** button repeatedly to set the time when you want the unit to turn on.
3. Wait 2 seconds, then the **TIMER ON** function will be activated. The digital display on your remote control will then return to the temperature display.

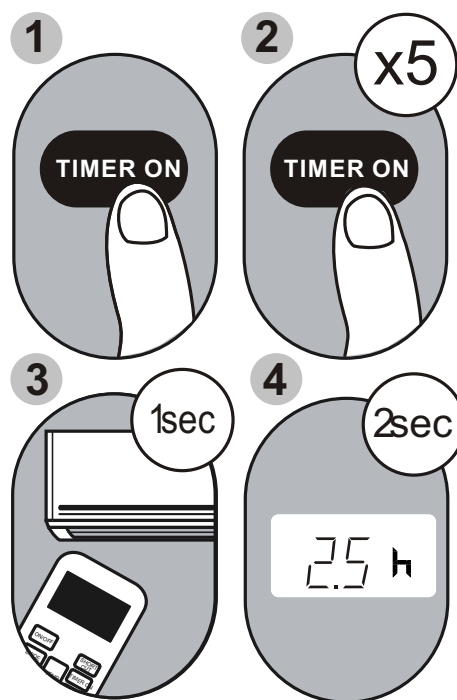

**Example:** Setting unit to turn on after 2.5 hours.

## TIMER OFF function

The **TIMER OFF** function allows you to set a period of time after which the unit will automatically turn off, such as when you wake up.

1. Press the **TIMER OFF** button. By default, the last time period that you set and an "h" (indicating hours) will appear on the display.  
**Note:** This number indicates the amount of time after the current time that you want the unit to turn off. For example, if you set **TIMER OFF** for 2 hours, " 2.0h " will appear on the screen, and the unit will turn off after 2 hours.
2. Press the **TIMER OFF** button repeatedly to set the time when you want the unit to turn off.
3. Wait 2 seconds, then the **TIMER OFF** function will be activated. The digital display on your remote control will then return to the temperature display.

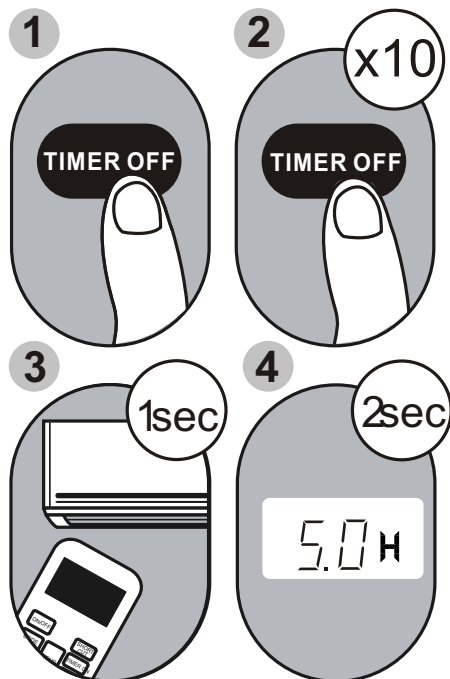

**Example:** Setting unit to turn off after 5 hours.

**NOTE:** When setting the **TIMER ON** or **TIMER OFF** functions, up to 10 hours, the time will increase in 30 minute increments with each press. After 10 hours and up to 24, it will increase in 1 hour increments. The timer will revert to zero after 24 hours. You can turn off either function by setting its timer to " 0.0h " .

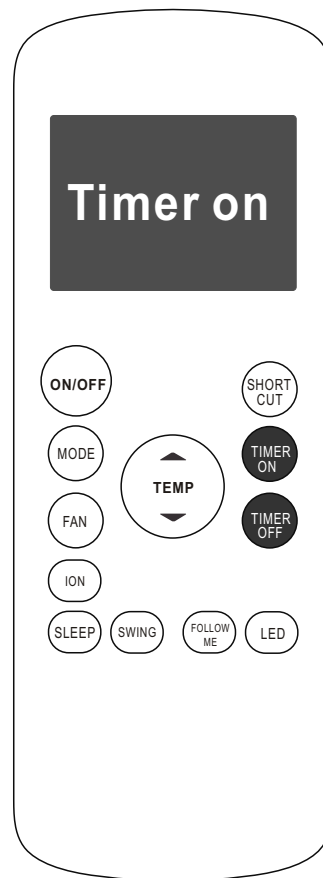

Continue to press **TIMER ON** or **TIMER OFF** until desired time is reached.

---

## Setting both TIMER ON and TIMER OFF at the same time

Keep in mind that the time periods you set for both functions refer to hours after the current time. For example, say that the current time is 1:00 PM, and you want the unit to turn on automatically at 7:00 PM. You want it to operate for 2 hours, then automatically turn off at 9:00 PM.

Do the following:

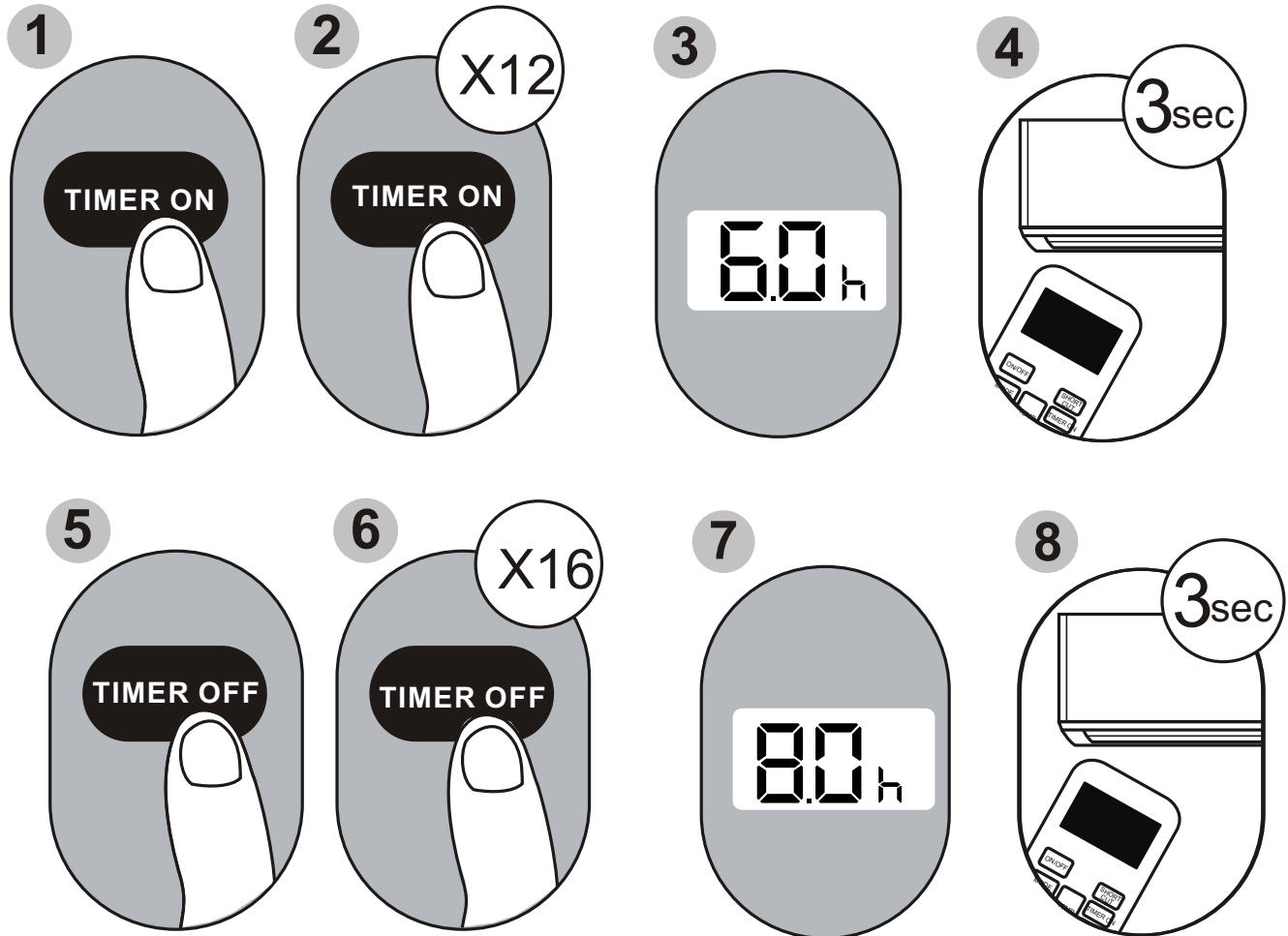

**Example:** Setting the unit to turn on after 6 hours, operate for 2 hours, then turn off (see the figure below)

**Your remote display**

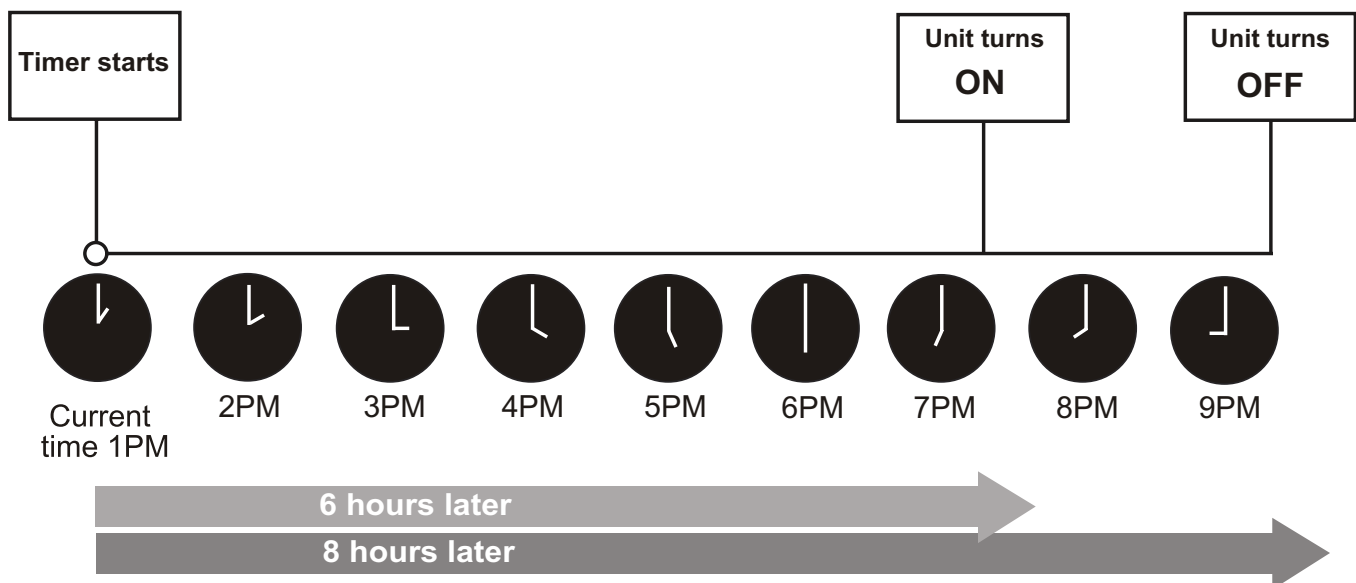
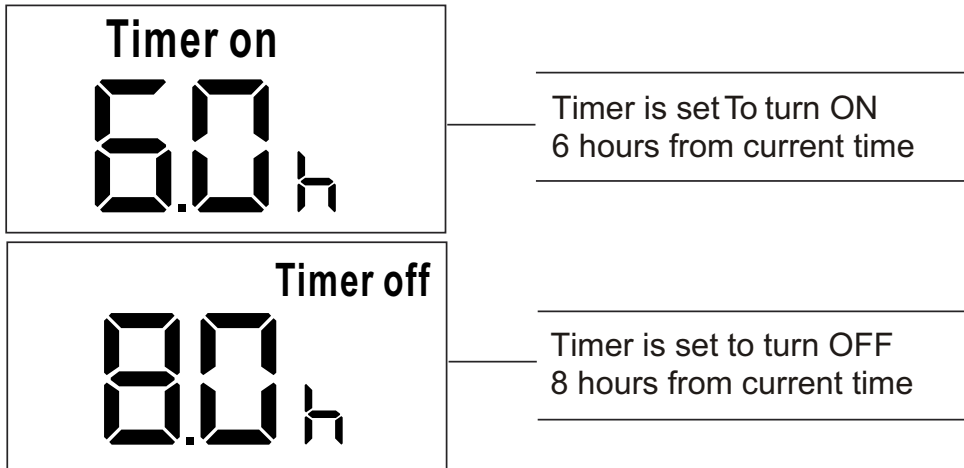



## How To Use The Advanced Functions

### SLEEP Function

The SLEEP function is used to decrease energy use while you sleep (and don't need the same temperature settings to stay comfortable).

**Note:** The SLEEP function is not available in FAN or DRY mode.

### SWING Function

Used to stop or start louver movement and set the desired up/down air flow direction. The louver changes 6 degrees in angle for each press (some models without). If keep pushing more than 2 seconds, the louver auto swing feature is activated.

### FOLLOW ME function

The FOLLOW ME function enables the remote control to measure the temperature at its current location. When using AUTO, COOL, or HEAT functions, measuring ambient temperature from the remote control (instead of from the indoor unit itself) will enable the air conditioner to optimize the temperature around you and ensure maximum comfort.

1. Press **FOLLOW ME** button to activate function. The remote control will send temperature signal to the unit every three minutes.
2. Press **FOLLOW ME** button again to turn off this function.

### SHORTCUT function

- Used to restore the current settings or resume previous settings.
- Push this button when remote controller is on, the system will automatically revert back to the previous settings including operating mode, setting temperature, fan speed level and sleep feature (if activated).
- If pushing more than 2 seconds, the system will automatically restore the current operation settings including operating mode, setting temperature, fan speed level and sleep feature (if activated).

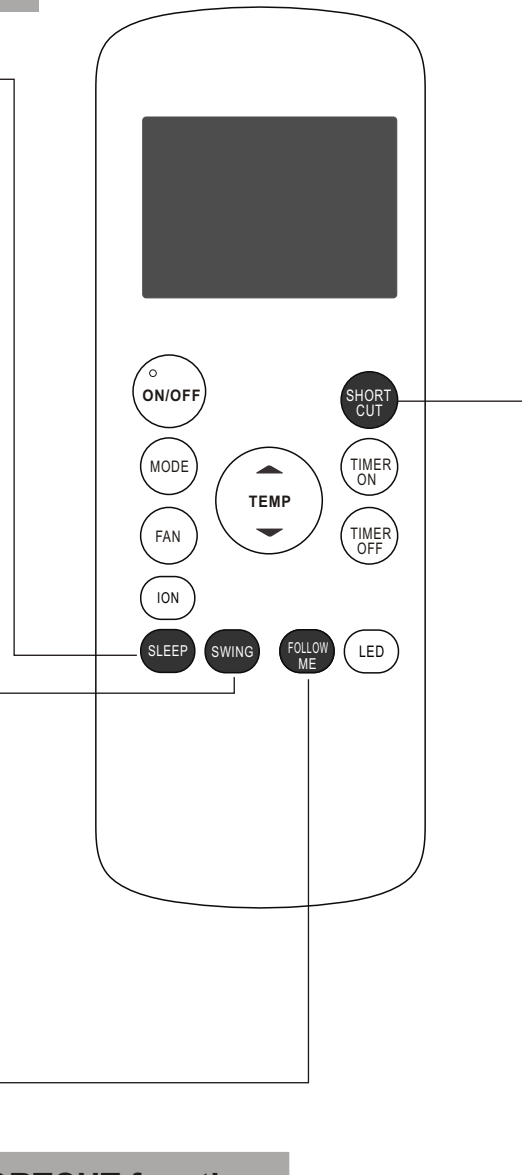

---

**NOTE:**

- Buttons design is based on typical model and might be slightly different from the actual one you purchased, the actual shape shall prevail.
- All the functions described are accomplished by the unit, if the unit has no this feature, there is no corresponding operation happened when press the relative button on the remote controller.
- When there are wide differences between“Remote controller Illustration” and“USER’S MANUAL”on function description, the description on“USER’S MANUAL”shall prevail.
- The device could comply with the local national regulations. In Canada, it should comply with CAN ICES-3(B)/NMB-3(B). In USA, this device complies with part 15 of the FCC Rules. Operation is subject to the following two conditions: (1) This device may not cause harmful interference, and (2) this device must accept any interference received, including interference that may cause undesired operation.
- This equipment has been tested and found to comply with the limits for a Class B digital device, pursuant to part 15 of the FCC Rules. These limits are designed to provide reasonable protection against harmful interference in a residential installation. This equipment generates, uses and can radiate radio frequency energy and, if not installed and used in accordance with the instructions, may cause harmful interference to radio communications. However, there is no guarantee that interference will not occur in a particular installation. If this equipment does cause harmful interference to radio or television reception, which can be determined by turning the equipment off and on, the user is encouraged to try to correct the interference by one or more of the following measures:
  - Reorient or relocate the receiving antenna.
  - Increase the separation between the equipment and receiver.
  - Connect the equipment into an outlet on a circuit different from that to which the receiver is connected.
  - Consult the dealer or an experienced radio/TV technician for help.Changes or modifications not approved by the party responsible for compliance could void suser’s authority to operate the equipment.



The design and specifications are subject to change without prior notice for product improvement. Consult with the sales agency or manufacturer for details.